

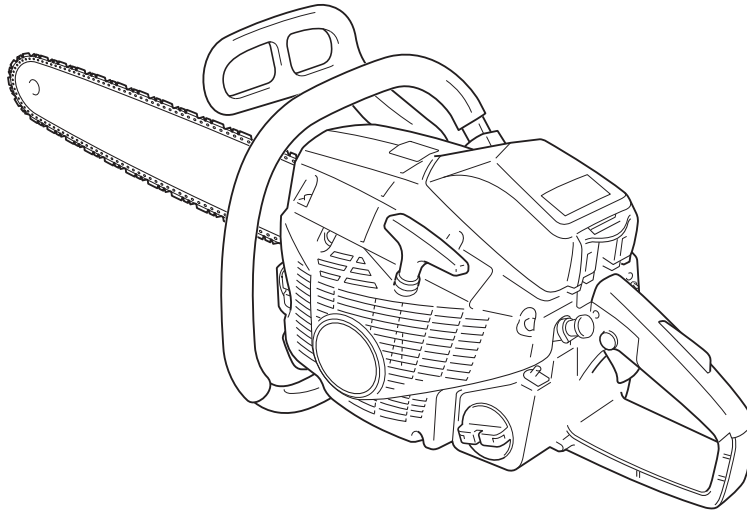

GB ENGLISH



OPERATOR'S MANUAL

CHAIN SAW CS-680S

WARNING



Read the instructions carefully and follow the rules for safe operation.
Failure to do so could result in serious injury.

Introduction

This chain saw is designed for cutting wood or wood products.
Do not cut solid metal, sheet metal, plastic or any non-wood materials.

It is important for you to understand all safety precautions correctly before using your chain saw.
Misuse of the chain saw can cause serious bodily injury.
Never let children operate the saw.

This manual shows rules of safe operation, proper use, servicing, and maintenance of your ECHO chain saw.
Follow these instructions in order to maintain a good operating condition and a long service life.
For future reference, you should keep this operator's manual.
If this operator's manual has become illegible through impairment or is lost, please purchase a new one from your ECHO dealer.

When renting or lending this machine to a person who will operate it, always include this operator's manual, which provides explanation and instructions.
When transferring a product, please deliver it attaching the operator's manual.

Specifications, descriptions and illustrative material in this literature are as accurate as known at the time of publication, but are subject to change without notice.
Illustrations may include optional equipment and accessories, and may not include all standard equipment.
The unit is delivered with guide bar and saw chain separated.
Install guide bar and chain.
If there is any clause in this manual that is hard to be understood, please contact your ECHO dealer.

Contents

Decals and symbols.....	4
Rules for safe operation.....	5
1. General precautions	5
2. Kickback safety precautions	7
3. Other safety precautions.....	8
Description.....	10
Assembly	11
Mounting guide bar and chain	11
Operation	12
Fuel and lubricant.....	12
Chain lubricant.....	12
Starting the cold engine.....	13
Starting the warm engine.....	14
Running	14
Stopping the engine.....	15
Checking chain tension.....	15
Chain lubrication test	15
Pre cutting test.....	15
Correct use of chain brake.....	16
Chain brake	16
Checking the brake function of the brake	17
Release the chain brake	17
Non-manual chain brake.....	17
Cutting instruction	18
General.....	18
Felling a tree	19
Limbing	20
Bucking.....	20
Tension and compression in timber.....	21
Service maintenance guide	22
Troubleshooting	23
Saw chain maintenance.....	24
Service.....	26
Air filter	26
Check fuel system	26
Fuel filter	26
Oil filter	26
Spark plug	26
Cylinder fins (Cooling system).....	27
Guide bar.....	27
Sprocket	27
Carburettor	27
Automatic oiler	27
Storage	28
Long term storage (Over 30 days).....	28
Disposal procedure	29
Specifications.....	30

Decals and symbols

DANGER

This symbol accompanied by the word "DANGER" calls attentions to an act or a condition which will lead to serious personal injury or death of operators and bystanders.

WARNING

This symbol accompanied by the word "WARNING" calls attentions to an act or a condition which can lead to serious personal injury or death of operators and bystanders.

CAUTION







"CAUTION" indicates a potentially hazardous situation which, if not avoided, may result in minor or moderate injury.



Circle and slash symbol means whatever is shown is prohibited.

NOTE

This enclosed message provide tips for use, care and maintenance of the unit.

Symbol form / shape	Symbol description / application	Symbol form / shape	Symbol description / application
	Carefully read the operator's manual		Chain oil fill
	Wear eyes, ears and head protection		Chain oiler adjustment
	Warning! Kickback may occur!	L	Carburettor adjustment - Low speed mixture
STOP	Emergency stop	H	Carburettor adjustment - High speed mixture
	Chain brake operation	T	Carburettor adjustment - Idle speed
	Oil and petrol mixture		

Locate this safety decal on your unit. The complete unit illustration found in the "Description" section will help you locate them.

Make sure the decal is legible and that you understand and follow the instructions on it. If a decal cannot be read, a new one can be ordered from your ECHO dealer.

Rules for safe operation

1. General precautions

Operator's manual



- ♦ Read the operator's manual for your chain saw carefully. Be thoroughly familiar with the chain saw's controls and how to use the chain saw properly. Failure to follow instructions could lead to personal injury.
- ♦ If you have any questions or problems, please contact your ECHO dealer.

Physical condition



- ♦ Do not operate a chain saw when you are fatigued or under the influence of alcohol or drugs.
- ♦ You should be in good physical and mental health in order to handle your chain saw safely. Errors in judgement or execution can be serious or fatal. If you have any physical condition which strenuous work could worsen, check with your physician before using a chain saw. Do not operate when ill or fatigued, or under the influence of any substance or medication which could affect your vision, dexterity or judgement.

Personal equipment

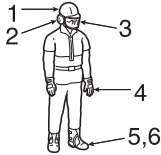

CAUTION

Stuffing ears with cotton is not recommended.

- ♦ Always wear approved goggles to protect your eyes. Wood chips, dust, snapping branches and other debris can be thrown by the cutting chain into the operator's facial area. Goggles may also offer limited protection in the event of the cutting chain hitting the operator in the eye area. If conditions warrant that a ventilated face shield be worn, goggles must be worn underneath it.
- ♦ ECHO advises wearing hearing protection at all times. If not followed, hearing loss can occur. You should reduce the risk of hearing damage by wearing either "headset" type protectors or ear plugs which are approved by an authorized organization.
- ♦ All persons who make part of their living using chain saws should be tested periodically for hearing deterioration.
- ♦ Always wear a cap or hat when working with a chain saw. A safety hard hat is highly recommended when felling or working under trees, or when objects can fall on you.
- ♦ Wear heavy duty, non-slip gloves for improved grip, and also for protection against cold and vibration.
- ♦ Safety tip shoes or boots with non-slip sole should be worn.
- ♦ Never wear loose clothing, unbuttoned jackets, flared sleeves and cuffs, scarves, tie-strings, neckties, cords, chains, jewellery, etc. which could snag the saw chain or underbrush.
- ♦ Clothing should be of sturdy, protective material. It should be snug-fitting to resist snagging, but roomy enough for freedom of movement.
- ♦ Trousers legs should not be flared or cuffed, and should be either tucked into the boot tops or trimmed short.
- ♦ Safety vests, leg chaps and logger's pants of ballistic material are available. It is the operator's responsibility to wear such additional protection if conditions warrant it.
- ♦ Never operate a chain saw when you are alone. Arrange to have someone remain within calling distance in case you need help.

Fuel

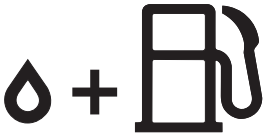

DANGER

- ♦ Petrol and fuel are extremely flammable. If spilled or ignited by ignition source, it can cause fire and serious injury or property damage. Extreme caution is required when handling petrol or fuel.
- ♦ After refuelling, tighten fuel cap firmly and check for leakage. In case of fuel leakage, repair before starting operation since there is a danger of fire.



1. Oil tank cap
 2. Fuel tank cap
- A: Tightening direction



- ♦ Use an appropriate type of fuel container.
- ♦ Bring an extinguisher or shovel in case of fire. Despite the precautions which can be taken, operating a chain saw, or just working in the forest, presents dangers.
- ♦ Do not smoke or bring flame or sparks near to fuel supplies.

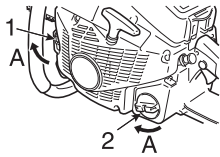

- ♦ The fuel tank may be under pressure. Always loosen the fuel cap and wait for pressure to be equalized before removing the cap.
- ♦ Fill the fuel tank outdoors over bare ground and install the fuel cap securely. Do not pour fuel indoors.
- ♦ Wipe any spilled fuel off the unit.
- ♦ Never refuel while the engine is still hot, or fuel a running engine.
- ♦ Do not store the unit with fuel in its tank, because a fuel leak could start a fire.

Starting engine

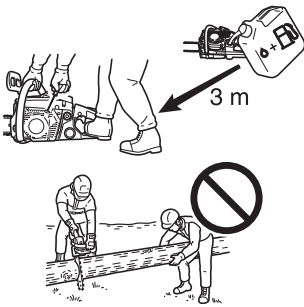

- ♦ Move the chain saw at least 3 m from the fuelling point before starting the engine.
- ♦ Do not allow other persons to be near the chain saw when you are starting or cutting with the chain saw. Keep bystanders and animals out of the work area. Do not let anyone hold wood for you to cut.
- ♦ Do not start cutting until you have a clear work area, secure footing and a planned retreat path from the falling tree.
- ♦ Before you start the engine, make sure that the saw chain is not contacting anything.
- ♦ Keep the handles dry, clean, and free of oil or fuel mixture.
- ♦ Operate the chain saw only in well-ventilated areas. Exhaust gas, oil mist (from chain saw lubrication) or saw dust is harmful to health.

Transportation

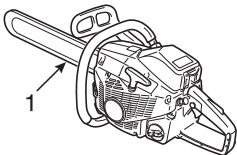

1. Guide bar cover
- ♦ When transporting your chain saw, use the appropriate guide bar cover.
 - ♦ Carry the chain saw with the engine stopped, the guide bar and saw chain to the rear, and the silencer away from your body.

2. Kickback safety precautions

DANGER

Kickback safety precaution for chain saw users: kickback may occur when the nose or tip of the guide bar touches an object or when the wood closes in and pinches the saw chain in the cut.

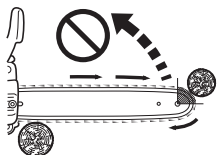
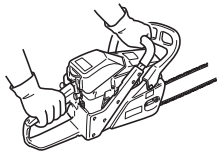
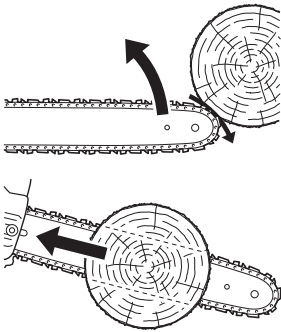

- ♦ In some cases, tip contact may cause a lightning-fast reverse reaction, kicking the guide bar up and back toward the operator (this is called a rotational kickback). Pinching the saw chain along the top of the guide bar may push the guide bar rapidly back toward the operator (this is called a linear kickback).
- ♦ Either or these reactions may cause you to lose control of the saw and come in contact with the moving chain, which could result in serious personal injury. As a chain saw user, you should take several steps to keep your cutting jobs free from accident or injury.
- ♦ With a basic understanding of kickback, you can reduce or eliminate the element of surprise. Sudden surprise contributes to accidents. Understand that rotational kickback is preventable by keeping an unshielded bar nose from touching an object or the ground.
- ♦ Do not operate a chain saw with one hand! Serious injury to the operator, helpers or bystanders may result from one-handed operation. For proper control, always use two hands when operating a chain saw, one of which operates the trigger. Otherwise, this can result in the chain saw "skating" or skidding, which can result in personal injury due to loss of control.
- ♦ Keep a good firm grip on the saw which both hands, with the right hand on the rear handle and the left hand on the front handle, when the engine is running. Use a firm grip with thumbs and fingers encircling the chain saw handles. A firm grip will help you reduce kickback and maintain control of the saw. Two hands must be used to control the saw at all times.
- ♦ Do not overreach or cut above chest height.
- ♦ Make sure that the area in which you are cutting is free from obstructions. Do not let the bar nose contact a log, branch, or any other obstruction which could be hit while you are operating the saw.
- ♦ Cutting at high engine speeds may reduce the likelihood of kickback. But cutting at part-throttle or low engine speeds may be preferable to control the chain saw in tight situations and may also reduce the likelihood of kickback.
- ♦ Follow manufacturer's sharpening and maintenance instructions for the saw chain.
- ♦ Use only replacement guide bars and chains specified by the manufacturer, or the acceptable equivalents of these guide bars and chains.

3. Other safety precautions

Vibration and cold



It is believed that a condition called Raynaud's Phenomenon, which affects the fingers of certain individuals, may be brought about by exposure to cold and vibration.

Accordingly, your ECHO chain saw has shock mounts designed to reduce the intensity of vibration received through the handles.

Exposure to cold and vibration may cause tingling and burning followed by loss of colour and numbness in the fingers.

We strongly recommend you take the following precautions because the minimum exposure which might trigger the ailment is unknown.

- ♦ Keep your body warm, especially the head and neck, feet and ankles, and hands and wrists.
- ♦ Maintain good blood circulation by performing vigorous arm exercises during frequent work breaks and also by not smoking.
- ♦ Limit the number of hours of chain saw operation.
Try to fill a part of each work day with jobs other than chain sawing.
- ♦ If you experience discomfort, redness and swelling of the fingers, followed by whitening and loss of feeling, consult your physician before further exposing yourself to cold and vibration.

Repetitive stress injuries

It is believed that over-using the muscles and tendons of the fingers, hands, arms and shoulders may cause soreness, swelling, numbness, weakness and extreme pain to the areas just mentioned.

To reduce the risk of repetitive stress injury, do the following:

- ♦ Avoid using your wrist in a bent, extended or twisted position.
Instead, try to maintain a straight wrist position.
Also, when grasping, use your whole hand, not just the thumb and index finger.
- ♦ Take periodic breaks to minimize repetition and rest your hands.
- ♦ Reduce the speed and force in which you do the repetitive movement.
- ♦ Do exercises to strengthen the hand and arm muscles.
- ♦ See a doctor if you feel tingling, numbness or pain in the fingers, hands, wrists or arms.

Machine conditions

WARNING

Do not modify a chain saw in any way.
Only attachments and parts supplied by ECHO or expressly approved by ECHO for use with the specific ECHO chain saw models are authorized.
Although certain unauthorized attachments are useable with the ECHO powerhead, their use may, in fact, be extremely dangerous.

- ♦ Do not operate a chain saw that is damaged, improperly adjusted, or not completely and securely assembled.
Do not operate the chain saw with a loose or defective silencer.
Be sure that the saw chain stops moving when the throttle control trigger is released.

Cutting

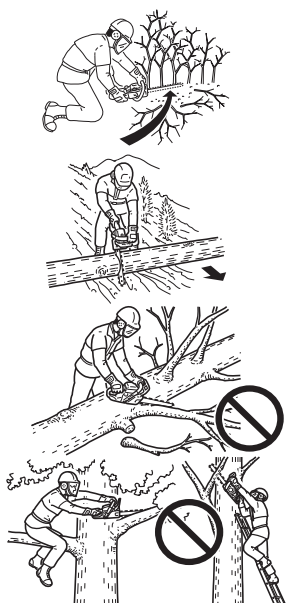

CAUTION

Do not touch hot surfaces of cylinder cover and silencer after you used the chain saw.

- ♦ Do not operate a chain saw in a tree unless you have been specifically trained to do so.
- ♦ Keep all parts of your body away from the saw chain when the engine is running.
- ♦ Use extreme caution when cutting small-size brush and saplings because slender material may catch the saw chain and be whipped toward you or pull you off balance.
- ♦ Stay on the uphill side when bucking or limbing logs which might roll when cut.
- ♦ When cutting a limb that is under tension, be alert for spring-back so that you will not be struck by the limb or chain saw when the tension in the wood fibres is released.
- ♦ Cutting while on a ladder is extremely dangerous because the ladder can slip and your control of the chain saw is limited.
Working aloft should be left to professionals.
- ♦ Keep both feet on the ground.
Do not work from off-the-ground positions.
- ♦ Stop the engine before setting the chain saw down.

Wood practices

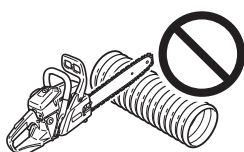

- ♦ Operating a chain saw safely requires a chain saw in proper working order, sound judgement, and knowledge of the methods which should be applied in each cutting situation.
- ♦ Do not let any person use your saw unless he has read this operator's manual and fully understands its instructions.
- ♦ Use your saw only to cut wood or wood products.
Do not cut solid metal, sheet metal, plastics or any non-wood materials.

Services

- ♦ All chain saw service operations, other than items listed in the operator's manual maintenance instructions, should be performed by competent service personnel.
(For example, if an improper tool is used to hold the flywheel in order to remove the clutch, structural damage to the flywheel could occur and subsequently could cause the flywheel to burst.)

Description

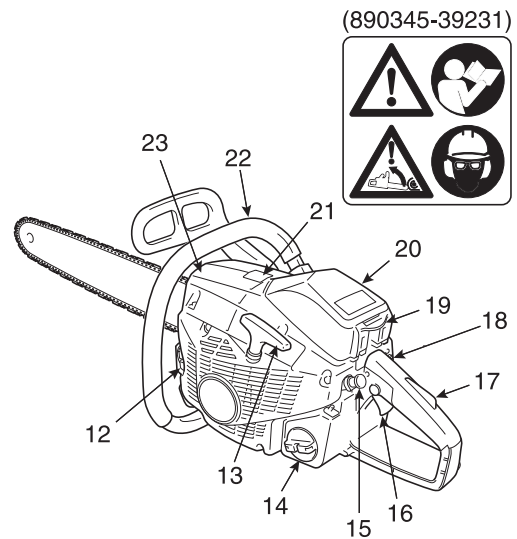
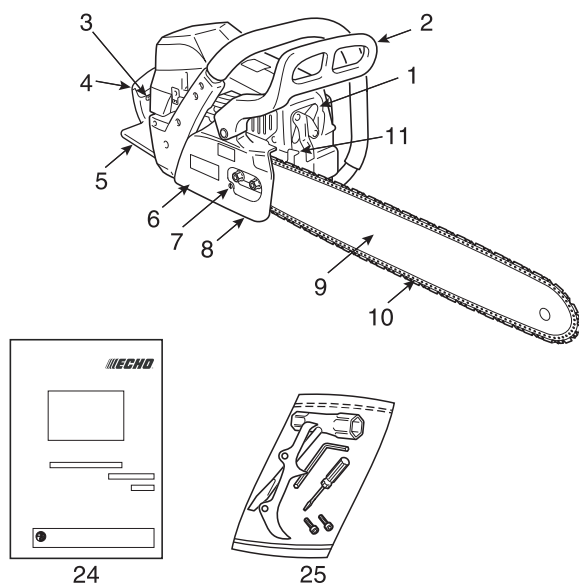

1. **Silencer** - The silencer controls the exhaust noise and prevents hot, glowing particles of carbon from leaving the silencer.
2. **Front hand guard** - Guard between the front handle and the saw chain for protecting the hand from injuries and aiding in control of the chain saw if the hand slips off the handle.
This guard is used to activate the chain brake which is to stop the saw chain rotation.
3. **Choke control knob** - Device for enriching the fuel / air mixture in the carburettor to aid cold starting.
4. **Rear handle (for the right hand)** - Support handle located towards the rear of the engine housing.
5. **Rear hand guard** - Extension on the lower part of the rear handle for protecting the hand from the chain if it breaks or degrooves.
6. **Clutch cover** - Protective cover to the guide bar, saw chain, clutch and sprocket when the chain saw is in use.
7. **Chain tension adjuster** - Device to adjust chain tension.
8. **Chain catcher** - A projection designed to reduce the risk of the operator's right hand from being hit by a chain which has broken or derailed from the guide bar during cutting.
9. **Guide bar** - The part that supports and guides the saw chain.
10. **Chain** - Chain, serving as a cutting tool.
11. **Spiked bumper** - Device, fitted in front of the guide bar mounting point, acting as a pivot when in contact with a tree or log.
12. **Oil tank cap** - For closing the oil tank.
13. **Starter handle** - The grip of the starter, for starting the engine.
14. **Fuel tank cap** - For closing the fuel tank.
15. **Manual oil pump** - Device for proper lubrication of chain.
16. **Throttle trigger** - Device activated by the operator's finger, for controlling the engine speed.
17. **Throttle trigger lockout** - A safety lever which must be depressed before the throttle trigger can be activated in order to prevent the accidental operation of the throttle trigger.
18. **Ignition switch** - Device for connecting and disconnecting the ignition system and thus allowing the engine to be started or stopped.
19. **Cleaner cover latch** - Device for installing the air cleaner cover.
20. **Air cleaner cover** - Covers air filter.
21. **Safety decal** - Part number 890345-39231
22. **Front handle (for the left hand)** - Support handle located at the front of the engine housing.
23. **Cylinder cover** - The cooling air flow grill. It cover the cylinder, spark plug and silencer.
24. **Operator's manual** - Included with unit.
Read before operation and keep for future reference to learn proper, safe operating techniques.
25. **Tools** - 13 x 19 mm T-wrench (combination screwdriver / spark plug socket), small screwdriver, 4 mm hexagonal wrench, spiked bumper and two bolts (5 x 12).

Assembly

Mounting guide bar and chain

WARNING

For your own safety, always stop the engine before performing any of the following operations.

CAUTION

1. All adjustments should be made cold.
2. Always wear gloves when working on chain.
3. Do not operate with a loose chain.

NOTE

Move the chain brake lever (Front hand guard) fully rearward to remove or install the clutch cover to the chain saw.

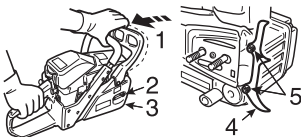

1. Release chain brake
2. Two nuts
3. Clutch cover
4. Spiked bumper
5. Two bolts

Install guide bar and chain as follows.

- ♦ Unscrew two nuts and remove clutch cover.
 - ♦ Install the spiked bumper on the front of machine. (Use two bolts.)
 - ♦ Mount the bar and slide toward clutch to make saw chain installation easier.
6. Guide bar
 7. Clutch
 8. Bar hole
 9. Tension adjuster
 10. Direction to tension the chain

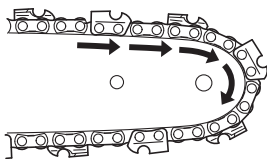
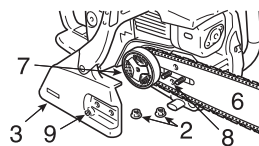
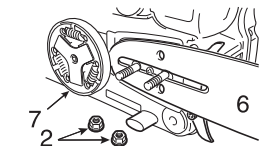

- ♦ Install saw chain as shown. (Ensure cutters are pointing in the right direction)

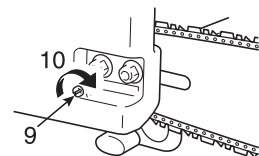

- ♦ Release the chain brake, and install the clutch cover over the guide bar studs. Tighten two nuts finger tight. Ensure that chain tension adjuster fits into bar hole.

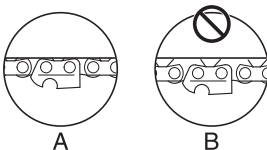

- ♦ Hold the bar nose up and turn the adjuster clockwise until the chain fits snugly against the underside of the bar.

A: Proper tension
B: Improper tension

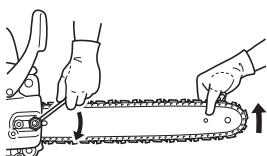

- ♦ Tighten both nuts with the bar nose held up.
- ♦ Pull the chain around the bar by hand. Loosen the adjustment if you feel tight spots.

Operation

Fuel and lubricant

CAUTION

Whenever opening up the fuel tank, always loosen the cap very slowly and wait for the tank pressure to be equalized before removing the cap.



- ♦ Fuel is a mixture of regular grade petrol and an air-cooled 2-stroke engine oil of reputable brand name.
Minimum 89 Octane unleaded petrol is recommended.
Do not use fuel containing methyl alcohol or more than 10 % of ethyl alcohol.
- ♦ Recommended mixture ratio; 50 : 1 (**2 %**) for ISO-L-EGD Standard (ISO/CD 13738), JASO FC, FD grade and ECHO Premium 50 : 1 oil or 25 : 1 (**4 %**) for JASO FB grade oil.
 - Do not mix directly in engine fuel tank.
 - Avoid spilling petrol or oil.
Spilled fuel should always be wiped up.
 - Handle petrol with care, it is highly inflammable.
 - Always store fuel in approved container.

Chain lubricant



Proper lubrication of the chain while in operation reduces the friction between the chain and the guide bar to a minimum and assures a longer life time.
Use only special chain oil of high quality for this purpose.
Do not use any waste or reclaimed oil to avoid various problems with the oil pump.

Starting the cold engine

WARNING

- ◆ After choke control knob is pulled and then knob is returned to original position, throttle remains a little open (latch condition).
- ◆ If engine is started in this latch condition, chain starts to turn.
Do not start engine before chain brake is activated.

CAUTION

1. After starting the engine, immediately squeeze and release throttle trigger for disengaging throttle latch and returning engine to idle, and pull front hand guard towards the operator immediately. (Chain brake RELEASED position)
2. Do not increase engine speed while chain brake is engaged.
3. Use the chain brake only in starting the engine or in emergencies.
4. Never use throttle latch for cutting.
Use it only when starting the engine.

NOTE

Do not pull starter rope out to the maximum position.
Do not allow starter handle to snap back against the casing.

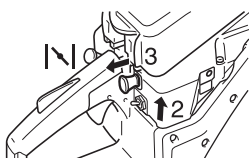
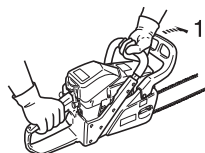
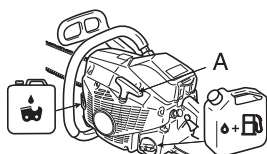

- A: Starter handle
1. Chain brake ACTIVATED position
 2. Ignition switch (Run)
 3. Choke control knob (Close)
 4. Choke control knob (Open)

- ◆ Fill the fuel tank with fuel mixture.
It is not permitted to fill fuel above the shoulder level of fuel tank.
- ◆ Fill the chain oil tank with lubricant.
- ◆ Press hand guard forward.
(Chain brake ACTIVATED position)
- ◆ Lift ignition switch up.

- ◆ Pull choke control knob all the way out.

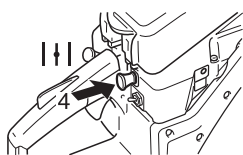
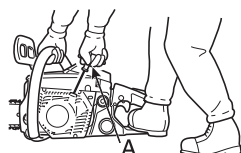

- ◆ Securely hold the chain saw.
- ◆ Make sure guide bar and saw chain are not touching anything when starting the saw.
- ◆ Pull starter handle several times until first firing sound is heard.
- ◆ Push choke control knob all the way in.
- ◆ Pull starter handle again.

Starting the warm engine

1. Chain brake ACTIVATED position
- ◆ Confirm there is fuel and chain oil in the tanks.
 - ◆ Press hand guard forward.
(Chain brake ACTIVATED position)
 - ◆ Lift ignition switch up.

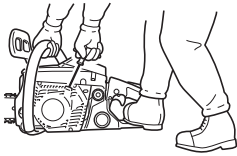
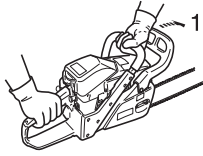

- ◆ Securely hold the chain saw.
- ◆ Pull starter handle.
- ◆ Choke may be used if necessary, but after first firing sound pull throttle trigger a little to release throttle latch and choke.
After choke control knob is pulled and then knob is returned to original position, throttle remains a little open (latch condition).

Running

1. Chain brake RELEASED position
 2. Throttle trigger lockout
 3. Throttle trigger
 4. Manual oiler button
- ◆ After engine starts, allow it to idle for a few minutes.
 - ◆ Pull front hand guard towards the operator immediately.
(Chain brake RELEASED position)

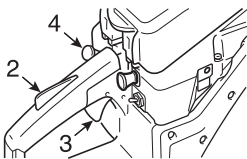
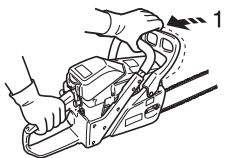

- ◆ Squeeze throttle trigger gradually to increase engine revolution.
- ◆ The chain starts moving when the engine reaches 3800 r/min approximately.
- ◆ Ensure proper acceleration and lubrication of saw chain and guide bar.
- ◆ Give several strokes to manual oiler button and confirm function, too.
- ◆ Do not run the engine at high speed unnecessarily.
- ◆ Be sure that saw chain stops moving when throttle trigger is released.

Stopping the engine

NOTE

If engine does not stop, pull choke control knob all the way out to stop engine. Return the unit to your authorized ECHO dealer to check and repair ignition switch before starting the engine again.

1. Throttle trigger
2. Ignition switch

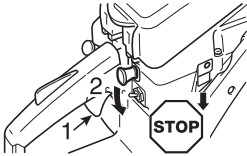

- ♦ Release throttle trigger and allow engine to idle.
- ♦ Push ignition switch down.

Checking chain tension

⚠ WARNING

Make sure that the engine is shut off when checking chain tension.

NOTE

Always loosen clutch cover nuts before turning the chain tension adjuster, otherwise the clutch cover and tensioner will be damaged.

- ♦ Chain tension should be checked frequently during work and corrected if necessary.
- ♦ Tension the chain as tight as possible, but so it can still be pulled easily along the bar by hand.

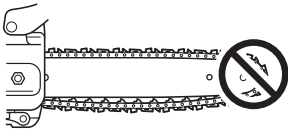

Chain lubrication test

- ♦ Hold the chain just above a dry surface and open the throttle to half speed for 30 seconds.
A thin line of "thrown" oil should be seen on the dry surface.

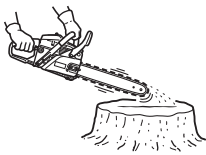

Pre cutting test

- ♦ Familiarize yourself with your chain saw before you start actual cutting.
- ♦ For this purpose it may be wise to practice by cutting some small logs or limbs several times.
- ♦ Do not allow either people or animals into the work area.
Multiple operators - Keep a safe distance between two or more operators when working together simultaneously.

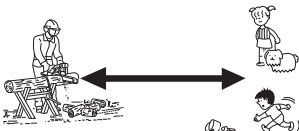

Correct use of chain brake

DANGER

Kickback motion is very hazardous.

If the tip of the bar touches wood or the like, the guide bar kicks back in an instant.

The chain brake reduces the possibility of injury due to kickback.

Always check that chain brake works properly before use.

NOTE

- For practice, while cutting a small tree, push the front guard forward to engage the brake.
- At all times, confirm whether the brake works properly before each task.
- If the chain brake is clogged with wood chips, function of the brake deteriorates a little. Always keep the device clean.
- Do not increase engine revolutions while the chain brake is engaged.
- Chain brake is used in emergencies. Do not use it unless absolutely necessary.
- When using throttle latch at starting, keep the chain brake in position. And after starting the engine, release the brake immediately.
- Never test the brake in an area where petrol fumes are present.

Chain brake

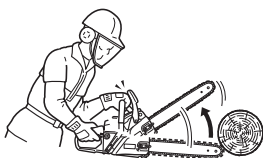

The chain brake's function is to stop chain rotation after a kickback.

It neither prevents nor reduces kickback.

Do not depend on the chain brake for protection against kickback.

Even with a chain brake, depend on your own good sense and proper cutting methods just as though there were no chain brake.

Even with normal use and proper maintenance, the response time of the brake may lengthen.

The following may interfere with the brake's ability to protect the operator:

- Saw wrongly held too close to operator's body. Kickback time may be too fast even for a perfectly maintained brake to work in time.
- The operator's hand may not be in position to contact the hand guard. Brake will not be tripped.
- Lack of proper maintenance lengthens the brake's stopping time, making it less effective.
- Dirt, grease, oil, pitch, etc. getting into the working parts of the mechanism may lengthen the stopping time.
- Wear and fatigue of the activating brake spring, and wear of the brake / clutch drum and pivot points may lengthen the brake's stopping time.
- A damaged hand guard and lever may render the brake inoperative.

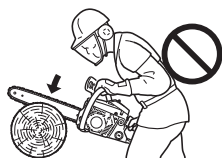

Checking the brake function of the brake

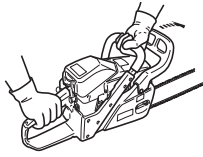

1. Place the chain saw on the ground.
2. Hold the handle with both hands and accelerate the engine to high speed by using the throttle trigger.
3. Operate the chain brake by turning your left wrist against the front hand guard whilst gripping the front handle.
4. The chain stop immediately.
5. Release the throttle trigger.

If the chain does not stop immediately, take the saw to your ECHO dealer to repair.

Release the chain brake

- ♦ When front hand guard is fully pulled towards the operator, chain brake is released.

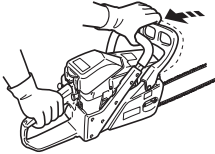

Non-manual chain brake

IMPORTANT

When checking the operation of the non-manual chain brake, use a soft surface substance like wood to provide the impact so the saw chain is not damaged.

- 1). **End of the guide bar** may be placed at the height about 35 cm.
- 2). **Rear handle** should be gripped lightly with the right handle.

The non-manual chain brake stops the operation of the saw chain in such a manner that the kickback action produced at the end of the guide bar non-manually actuates the chain brake. To make sure that the non-manual chain brake operates properly, proceed as follows:

1. **Stop the engine of the chain saw.**
2. Operate the front and rear handles with hands (grip them lightly), so that the guide bar may be placed at the height of about 35 cm as shown in Fig.
3. Softly detach the left hand from the front handle, and touch the end of the guide bar against the wood or the like placed below so that the machine receives an impact. (* at this time the rear handle should be gripped lightly with right hand)
4. The impact is transferred to the brake lever, which actuates the chain brake.

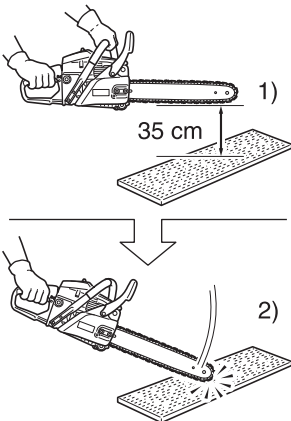

Cutting instruction

DANGER

Do not let the nose or tip of the guide bar touch anything while engine is running to avoid kickback.

IMPORTANT

Acids from decaying palm tree sap may corrode crankcase and oil tank housings made of aluminium and magnesium alloys.

To minimize the chance of this occurring, make sure to follow the cleaning procedure listed below.

Make sure to clean metal parts from palm sap **immediately** after use.

- ♦ Remove sprocket cover.
Clean wood chips and sawdust from cover and engine crankcase.
- ♦ Never use metal tools for cleaning which may scratch the metal paint and allow corrosion to develop.
- ♦ Clean sap accumulation from metal parts with cloth and warm water soap.
- ♦ Rinse with clean water and dry metal surfaces.
- ♦ Apply a light coating of engine or bar and chain oil to metal parts after they are cleaned.

General

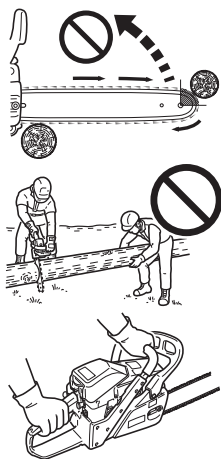

In all circumstances the operation of the chain saw is a one-man job.

It is difficult at times to take care of your own safety, so don't assume the responsibility for a helper as well.

After you have learned the basic techniques of using the saw, your best aid will be your own good common sense.

The accepted way to hold the saw is to stand to the left of the saw with your left hand on the front handle so you can operate the throttle trigger with your right index finger.

Before attempting to fell a tree, cut some small logs or limbs.

Be thoroughly familiar with the controls and the responses of the saw.

Start the engine, see that it is running properly.

Squeeze the trigger to open the throttle wide open, then start the cut.

It is not necessary to press down hard to make the saw cut.

If the chain is properly sharpened, the cutting should be relatively effortless.

Pushing the saw too hard will slow the engine and cutting will actually be more difficult.

Some material may adversely affect the housing of your chain saw.

(Example: palm tree acid, fertilizer etc.)

To avoid housing deterioration carefully remove all packed saw dust around clutch and guide bar area and wash with water.

Felling a tree

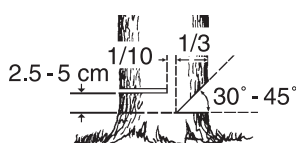
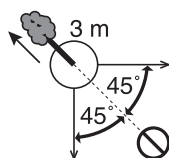

A falling tree can seriously damage anything it may hit - a car, a house, a fence, a power-line or another tree.

There are ways to make a tree fall where you want it, so first decide where that is!

Before cutting, clear the area around the tree.

You will need good footing while working and you should be able to work the saw without hitting any obstacles.

Next select a path of retreat.

When the tree begins to fall you should retreat away from the direction of fall at a 45-degree angle and at least 3 m from the trunk to avoid the trunk kicking back over the stump.

Begin the cut on the side to which the tree is to fall.

- ♦ Notch: 1/3 of diameter and 30° to 45° angle
- ♦ Back cut: 2.5 to 5 cm higher
- ♦ Uncut hinge wood: 1/10 of diameter

Cut a notch approximately 1/3 of the way into the tree.

The position of this notch is important since the tree will try to fall "into" the notch.

The felling cut is made on the side opposite the notch.

Make the felling cut by placing spiked bumper 2.5 cm to 5 cm above the bottom of the notch and stop cutting at approximately 1/10 of diameter to the inner edge of the notch in order to leave the uncut portion of the wood as a hinge.

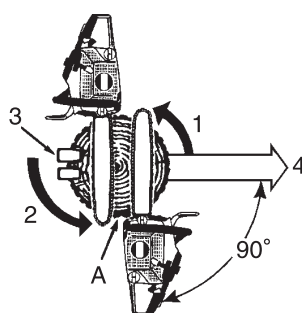

1. Notch cuts
 2. Back cut
 3. Wedges (when room)
 4. Fall
- A: Leave 1/10 of diameter hinge

Do not try to cut through to the notch with the felling cut.

The remaining wood between the notch cut and felling cut will act as a hinge when the tree falls, guiding it in the desired direction.

When the tree starts to fall, stop the engine, place the saw on the ground and make your retreat quickly.

Fell big tree.

1. Notching cuts
 2. Draw-across method
 3. Back cut
 4. Draw-across method
 5. Felling cuts
- A: Wedges

To fell big trees with a diameter exceeding twice the bar length, start the notching cuts from one side and draw the saw through to the other side of the notch.

Start the back cut on one side of the tree with the spiked bumper engaged, pivoting the saw through to form the desired hinge on that side.

Then remove the saw for the second cut.

Insert the saw in the first cut very carefully so as not to cause kickback.

The final cut is made by drawing the saw forward in the cut to reach the hinge.

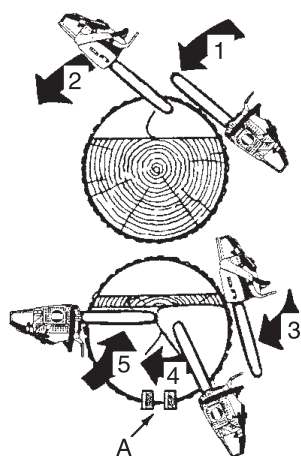

Limbing

CAUTION

Don't saw above chest height.

Limbing a fallen tree is much the same as bucking.
Never remove a limb from a tree while it is supporting your weight.
Be careful of the tip touching other limbs.
Always use both hands.

Don't cut with the saw overhead or the bar in a vertical position.
If the saw should kickback, you may not have good enough control to prevent possible injury.

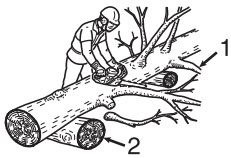
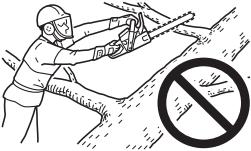

Know how limb is stressed

1. Leave supporting limbs till last.
2. Slide support logs under trunk.

Bucking

CAUTION

Stay on the uphill side of logs.

Bucking is the sawing of a log or fallen tree into smaller pieces.
There are a few basic rules which apply to all bucking operations.
Keep both hands on the handles at all times.
Support logs if possible.

When cutting on a slope or hillside, always stand uphill.

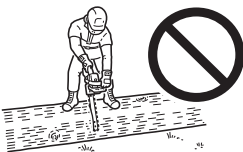

No standing on log.

Tension and compression in timber

WARNING

Never use throttle latch for cutting jobs.

CAUTION

If you have misjudged the effects of tension and compression, and cut from the wrong side, the timber will pinch the guide bar and chain, trapping it.

Racing the engine with the chain jammed will burn out your clutch.

If the chain should become jammed and the saw can not be removed from the cut do not force it out.

Stop the saw, force a wedge into the cut to open it up.

Never force the saw when it is jammed.

Do not force the saw into the cut.

A dull chain is unsafe and will cause excessive wear to the cutting attachments.

A good way to tell when the chain is dull is when fine saw dust comes out instead of chips.

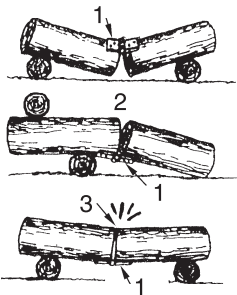

1. Hinge
2. Opened
3. Closed

A length of timber lying on the ground will be subject to tension and compression, depending at which points the major support is.

When timber is supported at its ends the compression side is at the top and the tension side is at the bottom.

To cut between these support points, make the first cut downwards approximately 1/3rd the timber diameter.

The second cut is made upwards and should meet the first cut.

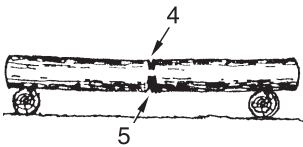

Heavy stress

4. 1/3 diameter. To avoid split.
5. Weakening cut to finish.

When the timber is supported at one end only, make the first cut upwards approximately 1/3rd the timber diameter.

The second cut is made downwards and should meet the first cut.

Overbuck

6. Down
7. Unsupported end

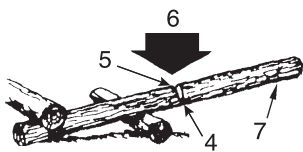

Underbuck

8. Up

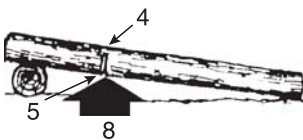

9. Wedge

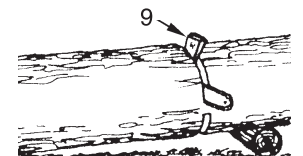

Make angled cut when one section may settle against the other.

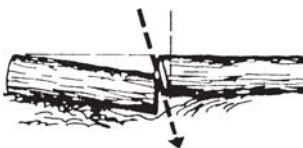

Service maintenance guide

Area	Maintenance	Page	Before use	Monthly
Air filter	Clean / Replace	26	•	
Fuel system	Inspect	26	•	
Fuel filter	Inspect / Clean / Replace	26	•	
Oil filter	Inspect / Clean / Replace	26	•	
Spark plug	Inspect / Clean / Adjust / Replace	26		•
Cooling system	Inspect / Clean	27	•	
Guide bar	Inspect / Clean	27	•	
Sprocket	Inspect / Replace	27		•
Carburettor	Adjust / Replace and adjust	27		•
Silencer	Inspect / Tighten / Clean	-	•	
Chain brake	Inspect / Replace	16	•	
Starter rope	Inspect	-	•	
Screws, bolts and nuts	Inspect, Tighten / Replace	-	•	

IMPORTANT

Time intervals shown are maximum.

Actual use and your experience will determine the frequency of required maintenance.

Troubleshooting

Trouble		Cause	Remedy
Engine	- hard to start - does not start		
Engine cranks	Fuel at carburettor Not fuel at carburettor	<ul style="list-style-type: none"> ♦ Fuel filter clogged ♦ Fuel line clogged ♦ Carburettor 	<ul style="list-style-type: none"> ♦ Clean or replace ♦ Clean ♦ Ask your ECHO dealer
	Fuel at cylinder No fuel at cylinder	<ul style="list-style-type: none"> ♦ Carburettor 	<ul style="list-style-type: none"> ♦ Ask your ECHO dealer
	Silencer wet with fuel	<ul style="list-style-type: none"> ♦ Fuel mixture is too rich 	<ul style="list-style-type: none"> ♦ Open choke ♦ Clean / replace air filter ♦ Adjust carburettor ♦ Ask your ECHO dealer
	Spark at end of plug wire No spark at end of plug wire	<ul style="list-style-type: none"> ♦ Ignition switch off ♦ Electrical problem 	<ul style="list-style-type: none"> ♦ Turn switch on ♦ Ask your ECHO dealer
	Spark at plug No spark at plug	<ul style="list-style-type: none"> ♦ Spark gap incorrect ♦ Covered with carbon ♦ Fouled with fuel ♦ Spark plug defective 	<ul style="list-style-type: none"> ♦ Adjust 0.6 to 0.7 mm ♦ Clean or replace ♦ Clean or replace ♦ Replace plug
Engine does not crank		<ul style="list-style-type: none"> ♦ Internal engine problem 	<ul style="list-style-type: none"> ♦ Ask your ECHO dealer
Engine runs	Dies or accelerates poorly	<ul style="list-style-type: none"> ♦ Air filter dirty ♦ Fuel filter dirty ♦ Fuel vent plugged ♦ Spark plug ♦ Carburettor ♦ Cooling system plugged ♦ Exhaust port / silencer plugged 	<ul style="list-style-type: none"> ♦ Clean or replace ♦ Clean or replace ♦ Clean ♦ Clean and adjust / replace ♦ Adjust ♦ Clean ♦ Clean

WARNING

- ♦ All chain saw service operations, other than items listed in the Operator's Manual, should be performed by competent service personnel.
- ♦ Fuel vapors are extremely flammable and may cause fire and / or explosion. Never test for ignition spark by grounding spark plug near cylinder plug hole, otherwise serious personal injury may result.

Saw chain maintenance

WARNING

Switch off the engine before sharpening the chain.
Always wear gloves when working on chain.

CAUTION

The following faults will increase the risk of kickback considerably.

- 1) Top plate angle too large
- 2) File diameter too small
- 3) Depth gauge too large

NOTE

These angles are referred to as Oregon 73LGX, 73LPX and Carlton A2LM saw chains.
For other branded saw chain, follow it's chain manufacturer's instruction.

- ♦ Properly filed cutters are shown below.

A: Top plate angle A2LM; 30°, 73LGX and 73LPX; 25°



B: Top plate cutting angle A2LM; 60°, 73LGX and 73LPX; 55°

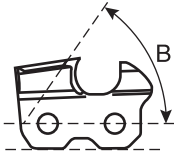

C: Depth gauge A2LM; 0.71 mm, 73LGX and 73LPX; 0.65 mm

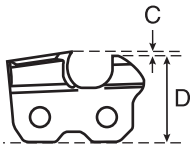

D: Parallel

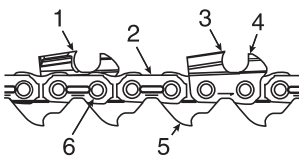

1. Left hand cutter
2. Tie strap
3. Right hand cutter
4. Depth gauge
5. Drive link
6. Rivet

Never operate a chain saw with a dull or damaged chain.

If the chain requires excessive pressure to cut or produces dust instead of wood chips then inspect the cutters for damage.

When sharpening the chain the objective will be to maintain the same angles and profiles throughout its life as when it was new.

Inspect the chain for damage or wear every time you refuel your chain saw.

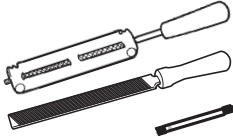

♦ Sharpening

In order to file the chain correctly you need: round file and file holder, flat file and a depth gauge tool.

By using the correct file size (5.5 mm Round file) and a file holder, it is easier to receive a good result.

Consult your ECHO dealer for correct sharpening tools and sizes.

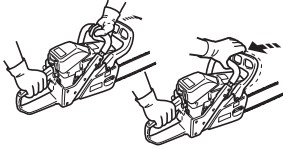

1. Lock the chain - push the front hand guard forward.
To rotate the chain - pull the front hand guard against front handle.

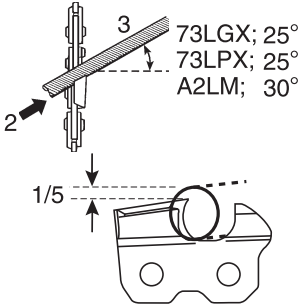

2. Your chain will have alternative left and right hand cutters.
Always sharpen from the inside out.
3. Keep the angle lines of the file holder parallel to the line of the chain and file the cutter back until the damaged area (side plate and top plate) has been removed.

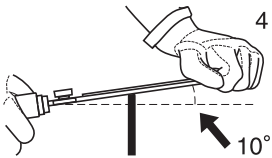

4. Hold the file tipped 10° upward.

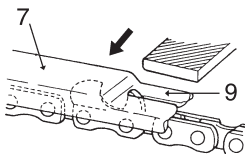

5. Avoid touching the tie straps with the file.
6. Sharpen the most damaged cutter first and then take all the other cutters back to the same length.
7. The depth control determines the thickness of wood chip produced and must be maintained correctly throughout the chain life.
8. As the cutter length is reduced, the depth control height is altered and must be reduced.
9. Position the depth gauge, and file off any of the depth control which protrudes.

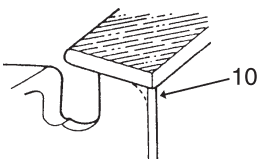

10. Round off the front of the depth control to allow smooth cutting.

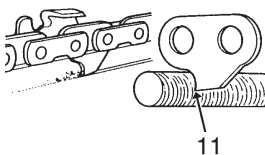

11. Drive link serves to remove sawdust from the groove of the guide bar.
Therefore, keep the lower edge of the drive link sharp.

When setting of the chain is finished, soak it in oil and wash away filings completely before using.

When the chain has been filed on the bar, supply sufficient oil to it, and rotate the chain slowly to wash away the filings before using again.

If the chain saw is operated with filings clogged in the groove, the saw chain and the guide bar will be damaged prematurely.

If the saw chain becomes soiled with resin for instance, clean it with kerosene and soak it in oil.

Service

- ♦ If you have any questions or problems, please contact your ECHO dealer.

Air filter

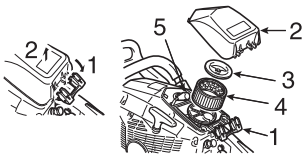

1. Cleaner cover latch
2. Air cleaner cover
3. Air filter cover
4. Air filter
5. Spark plug

- ♦ Check before every use.
- ♦ Close choke.
- ♦ Release the cleaner cover latch, and remove the air cleaner cover and the air filter. Brush off dust lightly, or clean with compressed air, or replace the air filter.
- ♦ Reinstall the air filter and cover, engage latch.

Check fuel system

- ♦ Check before every use.
- ♦ After refuelling, make sure fuel does not leak or exude from around fuel pipe, fuel grommet or fuel tank cap.
- ♦ In case of fuel leakage or exudation there is a danger of fire. Stop using the machine immediately and request your dealer to inspect or replace.

Fuel filter

DANGER

**Petrol and fuel are extremely flammable.
Extreme caution is required when handling petrol or fuel.**

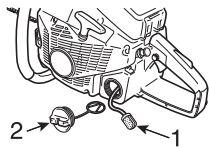

1. Fuel filter
 2. Fuel tank cap
- ♦ Check periodically.
 - Do not allow dust to enter fuel tank.
 - A clogged filter will cause difficulty in starting engine or abnormalities in engine performance.
 - Pick up the fuel filter through fuel inlet port with a piece of steel wire or the like.
 - When the filter is dirty, replace it.
 - When the inside of the fuel tank is dirty, it can be cleaned by rinsing the tank out with petrol.

Oil filter

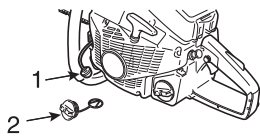

1. Oil filter
 2. Oil tank cap
- ♦ Check periodically.
 - Do not allow dust to enter oil tank.
 - A clogged oil filter will affect the normal lubricating system.
 - Pick it up through oil filling hole with a piece of steel wire or the like.
 - If the filter is dirty, wash it in petrol or replace it.
 - When the inside of the oil tank gets dirty, it can be cleaned by rinsing the tank out with petrol.

Spark plug

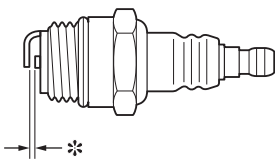

- * Spark plug gap: 0.6 to 0.7 mm
- ♦ Check periodically.
 - The standard spark gap is 0.6 to 0.7 mm.
 - Correct the spark gap if it is wider or narrower than the standard gap.
- ♦ Fastening torque: 15 to 17 N•m (150 to 170 kgf•cm)

Cylinder fins (Cooling system)

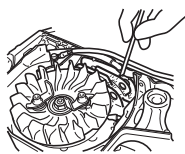

- ♦ Check periodically.
- ♦ Clogged fins will result in poor engine cooling.
- ♦ Remove dirt and dust from between fins to let cooling air pass easily.

Guide bar

NOTE

When replacing guide bar or saw chain, ask your ECHO dealer.

1. Groove
2. Oil hole
3. Guide bar
4. Sprocket

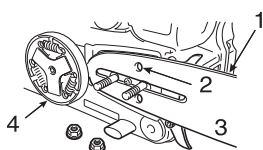

- ♦ Clean before using.
 - Clean the groove of the guide bar with a small screw driver, for example.
 - Clean oil holes with a wire.
- ♦ Reverse guide bar periodically.
- ♦ Check sprocket and the clutch and clean the bar mount area before installation of the guide bar. Replace either or both if worn.

Sprocket

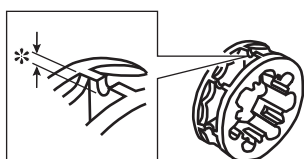

- * Worn out: 0.5 mm
- ♦ The damaged sprocket will cause premature damage or wear of saw chain.
 - When the sprocket has worn out 0.5 mm or more, replace it.
- ♦ Check sprocket when you install new chain. Replace it if worn.

Carburettor

CAUTION

**When starting, idle speed adjuster (T) should be adjusted not to rotate the saw chain.
When there is some trouble with the carburettor, contact your dealer.**

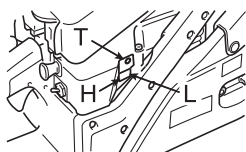

- L: Low speed mixture adjuster
H: High speed mixture adjuster
T: Idle speed adjuster

- ♦ Do not adjust the carburettor unless necessary.
- ♦ To adjust the carburettor proceed as follows:
 - Turn screws in the needles (L and H) clockwise until lightly seated and return as indicated below.
 - Low speed mixture adjuster (L): 1 to 1 and 1/2 turns open.
 - High speed mixture adjuster (H): 5/8 turns open.
 - Turn idle speed adjuster (T) clockwise until chain begins to rotate. Then back screw 1/2 turn.
 - Accelerate to full throttle to check for smooth transition from idle to full throttle.

Automatic oiler

1. Oil adjusting knob
2. Decrease
3. Increase

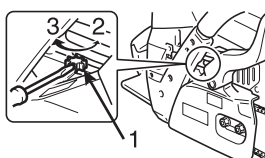

- ♦ The discharge volume of the automatic oiler is adjusted to 8 mL/min approximately at 7000 r/min, prior to shipment from factory.
 - To increase the delivery volume, turn the adjusting knob clockwise. When the adjusting knob touches stopper and stops, this position indicates maximum discharge volume. (15 mL/min at 7000 r/min)
 - Do not turn the adjusting knob beyond the maximum or minimum limit of volume adjustment.

Storage

Long term storage (Over 30 days)

WARNING

Do not store in an enclosure where fuel fumes may accumulate or reach an open flame or spark.

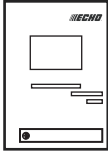

NOTE

For future reference, you should keep this operator's manual.

Do not store your unit for a prolonged period of time (30 days or longer) without performing protective storage maintenance which includes the following:

1. Drain the fuel tank completely and pull the recoil starter handle several times to remove fuel from the carburettor.
2. Always store fuel in approved container.
3. Place the ignition switch in the "STOP" position.
4. Remove accumulation of grease, oil, dirt and debris from exterior of unit.
5. Perform all periodic lubrication and services that are required.
6. Tighten all the screws, bolts and nuts.
7. Remove the spark plug and pour 10 mL of fresh, clean, two-stroke engine oil into the cylinder through the spark plug hole.
 - A. Place a clean cloth over the spark plug hole.
 - B. Pull the recoil starter handle 2 or 3 times to distribute the oil inside the cylinder.
 - C. Observe the piston location through the spark plug hole.
Pull the recoil starter handle slowly until the piston reaches the top of its travel and leave it there.
8. Install the spark plug (Do not connect ignition cable).
9. Cover the chain and the guide bar with the guide bar cover before putting them in storage.
10. Store unit in a dry, dust free place, out of the reach of children and other unauthorized persons.

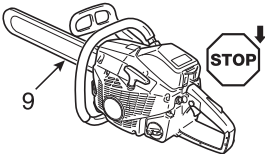

Disposal procedure



- ♦ Dispose of waste oil in accordance with local regulations.
- ♦ Major plastic parts making up the product have codes showing their materials. The codes refer to the following materials; dispose of those plastic parts in accordance with local regulations.

Mark	Material
>PA6-GF<	Nylon 6 - Glass fibre
>PP-GF<	Polypropylene - Glass fibre
>PE-HD<	Polyethylene

- ♦ Please contact your ECHO dealer in case you do not know how you should dispose of waste oil / plastic parts.

Specifications

Model		CS-680S
External dimensions: Length x Width x Height	mm	435 x 236 x 302
Mass: Saw without guide bar and chain, empty tanks	kg	6.6
Volume: Fuel tank Tank for chain lubrication oil Fuel (Mixture ratio) Oil (Chain oil)	mL mL	640 370 Regular grade petrol. Minimum 89 Octane unleaded petrol is recommended. Do not use fuel containing methyl alcohol or more than 10 % of ethyl alcohol. 50 : 1 (2 %) for ISO-L-EGD Standard (ISO/CD13738), JASO FC, FD grade and ECHO Premium 50 : 1 oil or 25 : 1 (4 %) for JASO FB grade oil. Special chain oil
Cutting length: All specified usable cutting lengths of guide bar	mm	500, 600, 700
Chain: Specified pitch Specified gauge (thickness of drive links) Type of guide bar Guide bar gauge Type of chain Lubrication	mm mm cm mm	9.53 (3/8 inch) 1.47 (0.058 inch) 50, 60, 70 (ECHO) 1.47 (0.058 inch) Carlton A2LM Oregon 73LGX, 73LPX Adjustable automatic oil pump and manual pump
Sprocket: Specified number of teeth		7
Engine: Type Carburettor Magneto Spark plug Starter Power transmission Engine displacement Maximum shaft brake power (ISO 7293) Recommended maximum speed with cutting attachment Recommended speed at idling	mL (cm ³) kW r/min r/min	Air cooled 2-stroke single cylinder Diaphragm type Flywheel magneto, CDI system NGK BPM7A Recoil starter Automatic centrifugal clutch 66.8 3.3 12500 2600 (2200 - 3200)
Fuel consumption: Fuel consumption at maximum engine power	L/h	2.20
Other devices:		Front hand guard, Rear hand guard, Throttle trigger lockout, Chain catcher, Chain brake, Anti-vibration device, Spiked bumper

Memorandum

YAMABIKO CORPORATION

7-2 SUEHIROCHO 1-CHOME, OHME, TOKYO 198-8760, JAPAN

PHONE: 81-428-32-6118. FAX: 81-428-32-6145.

